

Product data sheet

Characteristics

9070T1000D1

Transformer, Type T, industrial control, 1000 VA,
240/480 VAC primary / 120 VAC secondary, 1
phase, 50/60 Hz, 115 °C



Product availability: Stock - Normally stocked in distribution facility

Price*: 585.00 USD



Main

Product or component type	Industrial Control Transformer
Rated power in VA	1000 VA
Range of product	T

Complementary

Phase	1 phase
Rated power in VA	1000 VA UL 1000 VA CSA 1000 VA NOM 630 VA
Temperature rise	115 °C
Electrical connection	Screw clamp terminals
Height	4.51 In (114.55 mm)
Width	5.25 In (133.35 mm)
Depth	6.3 In (160.02 mm)
Material	Copper winding
Product compatibility	FSC2

Environment

Product certifications	UL listed file E61239 CSA file LR37055 guide 184-N-90
NEMA degree of protection	Not rated (open device)
Insulation temperature	356 °F (180 °C)

Ordering and shipping details

Category	16201 - 9070 T (NOT TF) 250-2000VA
Discount Schedule	CP8
GTIN	00785901904724
Nbr. of units in pkg.	1
Package weight(Lbs)	21.55 Lb(US) (9.775 kg)
Returnability	Yes
Country of origin	MX

Packing Units

Unit Type of Package 1	PCE
Package 1 Height	8.40 In (21.336 cm)
Package 1 width	8.10 In (20.574 cm)
Package 1 Length	6.80 In (17.272 cm)

Offer Sustainability

Sustainable offer status	Green Premium product
California proposition 65	WARNING: This product can expose you to chemicals including: Phenyl glycidyl ether, which is known to the State of California to cause cancer and birth defects or other reproductive harm. For more information go to www.P65Warnings.ca.gov
REACH Regulation	REACH Declaration
EU RoHS Directive	Compliant EU RoHS Declaration
Mercury free	Yes
RoHS exemption information	Yes
China RoHS Regulation	China RoHS Declaration
Environmental Disclosure	Product Environmental Profile
PVC free	Yes

Contractual warranty

Warranty	10 Years
----------	----------

Approximate Dimensions

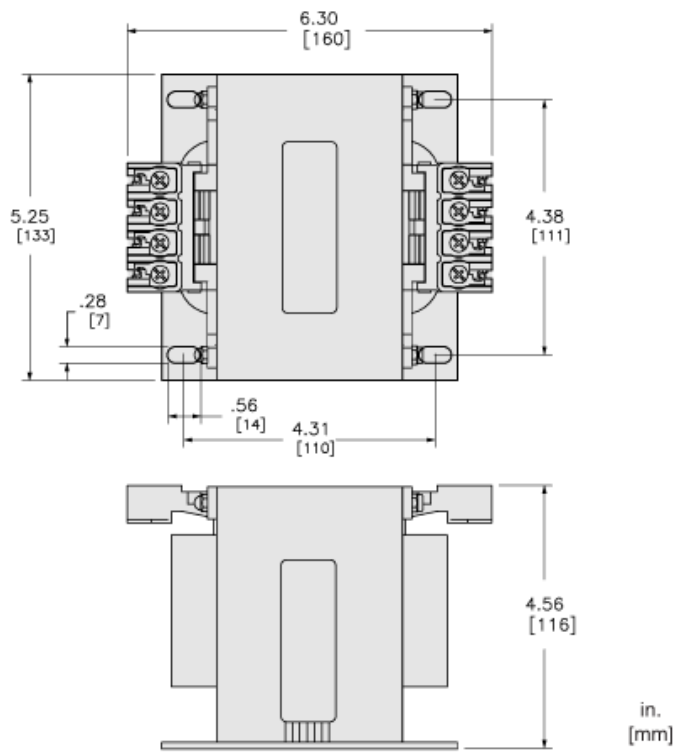

Connections and Wiring Diagrams

Voltage and Connection Options

Voltage Code	Voltages		Connections	
	Primary	Secondary	Primary	Secondary
D1	220 x 440	110	220/230/240 V: Connect to H1 and H4 Jumper H1 and H3	Connect to X1 and X2
	230 x 460	115	Jumper H2 with H4	
	240 x 480	120	440/460/480 V: Connect to H1 and H4 Jumper H2 with H3	

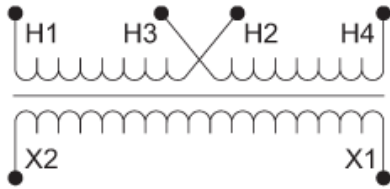

Product Life Status : Commercialised